Glasfaser Keystone-Module

Art.-Nr.: SC OS2 GN
SC OM2 BG
SC OM4 EV
SC OM3 AQ

Abdeckungen

Art.-Nr.: .. 569-1 WE ..., .. 569-2 WE ...,
.. 1969-1 .. WE ..., .. 1969-2 .. WE ..

ALBRECHT JUNG GMBH & CO. KG

Volmestraße 1
58579 Schalksmühle
GERMANY

Tel. +49 2355 806-0
Fax +49 2355 806-204
kundencenter@jung.de
www.jung.de

03/2025
0024100200

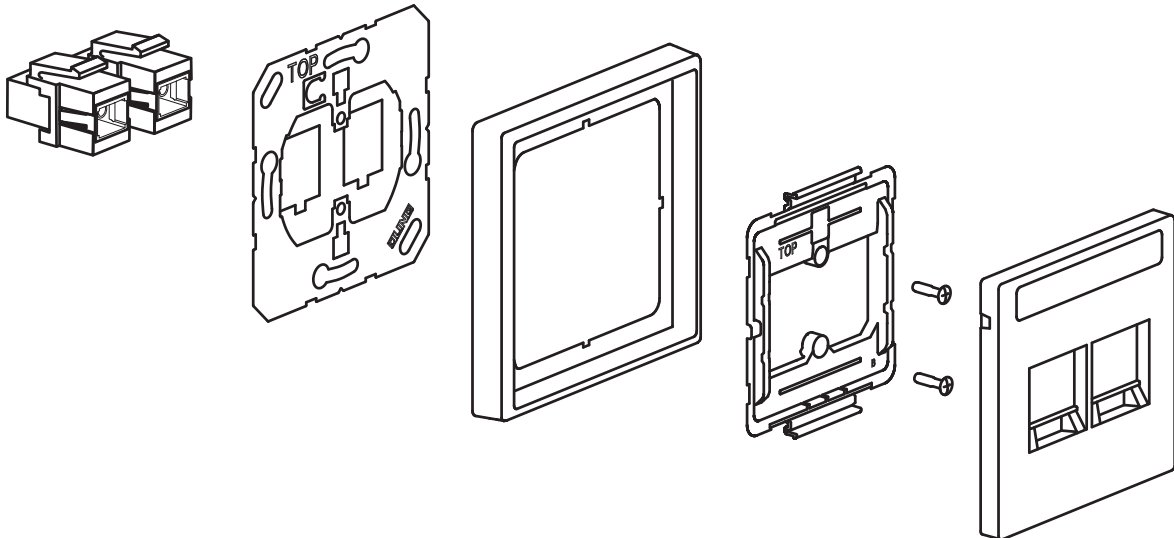

1

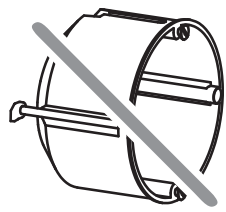
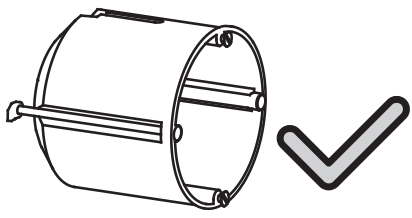

2

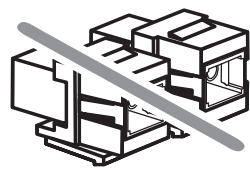
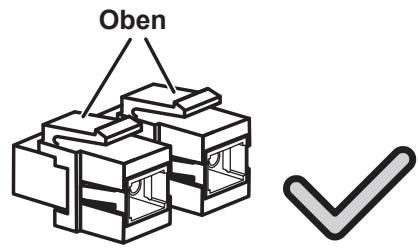

1

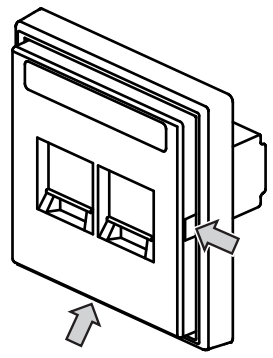

≤ 3 mm

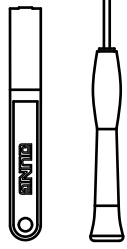

2

